

20-W MONO DIGITAL INPUT AUDIO AMPLIFIER

FEATURES

- **Digital Interface**
 - 24-bit Resolution
 - Supports I²S and 16-Bit Word Right-Justified Digital Input Formats
 - Multiple Sampling Frequencies: 5 kHz – 200 kHz
 - 8x Oversampling Digital Filter
 - Soft Mute
- **Power Amplifier**
 - 20-W into an 8-Ω Load from an 18-V Supply
 - Efficient Operation Eliminates Need for Heat Sinks
 - Three Selectable, Fixed Gain Settings
 - Thermal and Short-Circuit Protection

DESCRIPTION

The TPA3200D1 is a 20-W (per channel) efficient, digital audio power amplifier for driving a bridged-tied speaker. The TPA3200D1 can drive a speaker with an impedance as low as 4 Ω. The high efficiency of the TPA3200D1 (85%) eliminates the need for an external heat sink.

The digital input accepts 16-24 bit data in I²S format or 16-bit word right-justified. A digital filter performs an 8x interpolation function. Other features include soft mute, a zero input detect output flag for power conscious designs, and power saving shutdown mode.

Simplified Application Circuit

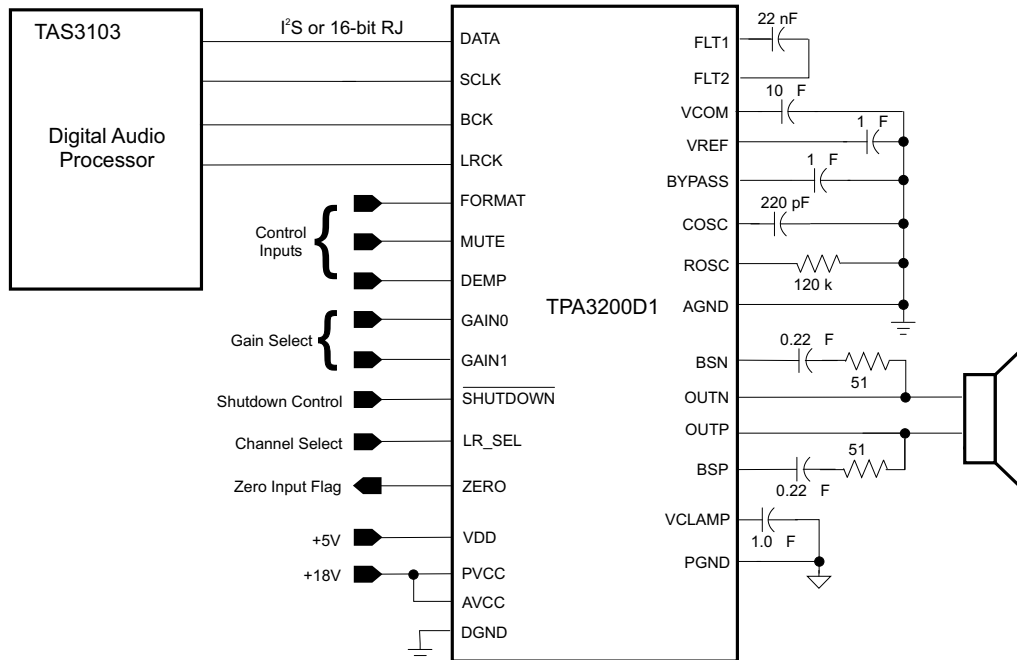

Please be aware that an important notice concerning availability, standard warranty, and use in critical applications of Texas Instruments semiconductor products and disclaimers thereto appears at the end of this data sheet.

PowerPAD is a trademark of Texas Instruments.



These devices have limited built-in ESD protection. The leads should be shorted together or the device placed in conductive foam during storage or handling to prevent electrostatic damage to the MOS gates.

AVAILABLE OPTIONS

T_A	PACKAGED DEVICE 44-PIN (DCP) ⁽¹⁾
–40°C to 85°C	TPA3200D1DCP

- (1) The DCP package is available taped and reeled. To order a taped and reeled part, add the suffix R to the part number (e.g., TPA3200D1DCPR).

ABSOLUTE MAXIMUM RATINGS

over operating free-air temperature range (unless otherwise noted)⁽¹⁾

		TPA3200D1	UNIT
V_{SS}	Supply voltage, VCC, PVCC	–0.3 to 21	V
	Supply voltage, VDD	–0.3 to 6.5	V
R_L	Load Impedance	≥ 3.6	Ω
V_i	SHUTDOWN	– 0.3 to $V_{CC} + 0.3$	V
	GAIN0, GAIN1, BCK, SCLK, DATA, LRCK, LR_SEL	–0.3 to $V_{DD} + 0.3$	V
	FORMAT, MUTE, DEMP		
Continuous total power dissipation		See Dissipation Rating Table	
T_A	Operating free-air temperature range	–25 to 85	°C
T_J	Operating junction temperature range	–25 to 150	°C
T_{stg}	Storage temperature range	–65 to 150	°C
	Lead temperature 1.6 mm (1/16 inch) from case for 10 seconds	260	°C

- (1) Stresses beyond those listed under absolute maximum ratings may cause permanent damage to the device. These are stress ratings only, and functional operations of the device at these or any other conditions beyond those indicated under recommended operating conditions is not implied. Exposure to absolute-maximum-rated conditions for extended periods may affect device reliability.

DISSIPATION RATINGS

PACKAGE	$T_A \leq 25^\circ\text{C}$	DERATING FACTOR ($1/\theta_{JA}$)	$T_A = 70^\circ\text{C}$	$T_A = 85^\circ\text{C}$
44-pin DCP	4.89 W	39.1 mW/°C ⁽¹⁾	3.13 W	2.54 W

- (1) Based on a JEDEC high-K PCB with the PowerPAD™ soldered to a thermal land on the printed-circuit board. See the *PowerPAD Thermally Enhanced Package* technical brief, literature number [SLMA0002](#). The PowerPAD must be soldered to the PCB.

RECOMMENDED OPERATING CONDITIONS

	PARAMETER	PIN NAME	MIN	MAX	UNIT
V _{SS}	Supply voltage	PVCC, VCC	8	18	V
		VDD	4.5	5.5	
V _{IH}	High-level input voltage	SHUTDOWN, GAIN0, GAIN1, BCK, SCLK, DATA, LRCK, FORMAT, MUTE, DEMP	2		
V _{IL}	Low-level input voltage	SHUTDOWN, GAIN0, GAIN1, BCK, SCLK, DATA, LRCK, FORMAT, MUTE, DEMP		0.8	
V _{IH}	High-level input voltage	LR_SEL	VDD x 0.7		
V _{IL}	Low-level input voltage	LR_SEL		VDD x 0.3	
I _{IH}	High-level input current	SHUTDOWN: V _I = VCC, VCC = 12 V		1	μA
		GAIN0, GAIN1, LR_SEL: V _I = VDD, VDD = 5 V		1	
		SCLK, BCK, DATA, LRCK: V _I = VDD, VDD = 5 V		10	
		FORMAT, MUTE, DEMP: V _I = VDD, VDD = 5 V		100	
I _{IL}	Low-level input current	SHUTDOWN: V _I = 0 V, VCC = 12 V		1	μA
		GAIN0, GAIN1, LR_SEL: V _I = 0 V, VDD = 5 V		1	
		BCK, SCLK, DATA, LRCK, FORMAT, MUTE, DEMP: V _I = 0 V, VDD = 5 V		10	
V _{OH}	High-level output voltage	I _{OH} = -1 mA, ZERO	2.4		V
V _{OL}	Low-level output voltage	I _{OL} = 1 mA, ZERO		0.4	
f _{OSC}	Oscillator frequency		200	300	kHz

ELECTRICAL CHARACTERISTICS

 All specifications at T_A = 25°C, V_{DD} = 5 V, f_S = 44.1 kHz, system clock = 384 f_S and 24-bit data, unless otherwise noted

PARAMETER		TEST CONDITIONS	MIN	TYP	MAX	UNIT
POWER SUPPLY REQUIREMENTS⁽¹⁾						
I _{DD}	Supply current	f _S = 44.1 kHz		26	31	mA
		f _S = 96 kHz		25		
		f _S = 192 kHz		30		
DIGITAL FILTER PERFORMANCE						
FILTER CHARACTERISTICS						
	Pass band	±0.04 dB			0.454 f _S	
	Stop band		0.546 f _S			
	Pass-band ripple			±0.04		dB
	Stop-band attenuation	Stop band = 0.546 f _S	-50			dB
ANALOG FILTER PERFORMANCE						
	Frequency response	At 20 kHz		-0.03		dB
		At 44 kHz		-0.20		
SAMPLING FREQUENCY						
f _S	Sampling frequency		5		200	KHz
DYNAMIC PERFORMANCE						
	Channel separation	f _S = 44.1 KHz, 96 KHz, 192 KHz		100		dB

 (1) Conditions in 192-kHz operation are system clock = 128 f_S and oversampling rate = 64 f_S of register 18.

FORMAT CHARACTERISTICS

All specifications at $T_A = 25^\circ\text{C}$, $V_{DD} = 5\text{ V}$, $f_S = 44.1\text{ kHz}$, system clock = $384 f_S$ and 24-bit data, unless otherwise noted

PARAMETER	TEST CONDITIONS	MIN	TYP	MAX	UNIT
Resolution			24		Bits
Data					
Audio-data interface format Audio	I ² S, standard				
Audio-data bit length Audio	16–24-bit (I ² S), 16-bit (Right-justified)				
Audio data format	MSB first, 2s complement				
System clock frequency	128 f_S , 192 f_S , 256 f_S , 384 f_S , 512 f_S , 768 f_S , 1152 f_S				

ELECTRICAL CHARACTERISTICS

at $T_A = 25^\circ\text{C}$, $PV_{CC} = V_{CC} = 12\text{ V}$ (unless otherwise noted)

PARAMETER	TEST CONDITIONS	MIN	TYP	MAX	UNIT
V _{OS}	Output offset voltage (measured differentially) MUTE = 2 V A _V = 12 dB			100	mV
PSRR	Power supply rejection ratio PV _{CC} = 11.5 V to 12.5 V		–73		dB
V _{REF}	5 V regulator voltage I _L = 10 mA, V _{CC} = 8 V – 18 V	4.55	4.9	5.45	V
I _{CC}	Supply current SHUTDOWN = 2.0 V, No load		8	15	mA
	SHUTDOWN = V _{CC} , V _{CC} = 18 V, P _O = 20 W, R _L = 8 Ω		1.3		A
I _{CC(SD)}	Supply current shutdown mode SHUTDOWN = 0.8 V		1	2	μA
r _{DS(on)}	Output transistor on resistance (high side and low side) I _O = 0.5 A, T _J = 25°C	0.5	0.6	0.7	Ω
G	Gain GAIN1 = 0.8 V, GAIN0 = 0.8 V	10.9	12	13.1	dB
	GAIN1 = 0.8 V, GAIN0 = 2 V	17.1	18	18.6	
	GAIN1 = 2 V, GAIN0 = 0.8 V	22.9	23.6	24.4	

OPERATING CHARACTERISTICS

PV_{CC} = V_{CC} = 12 V, T_A = 25° C unless otherwise noted

PARAMETER	TEST CONDITIONS	MIN	TYP	MAX	UNIT
P _O	Continuous output power at 10% THD+N f = 1 kHz, R _L = 4 Ω		12.8		W
		f = 1 kHz, R _L = 8 Ω		9	
	Continuous output power at 1% THD+N f = 1 kHz, R _L = 4 Ω		10.3		
		f = 1 kHz, R _L = 8 Ω		7.5	
THD+N	Total harmonic distortion plus noise P _O = 10 W, R _L = 4 Ω f = 20 Hz to 20 kHz		0.2%		
B _{OM}	Maximum output power bandwidth THD = 1%		20		kHz
k _{SVR}	Supply ripple rejection ratio f = 1 kHz, C _(BYPASS) = 1 μF		–60		dB
SNR	Signal-to-noise ratio P _O = 10 W, R _L = 4 Ω		95		
V _n	Noise output voltage C _(BYPASS) = 1 μF, A-weighted filter f = 20 Hz to 22 kHz, Gain = 12 dB		150		μV(rms)
			–76.5		dBV

Functional Block Diagram

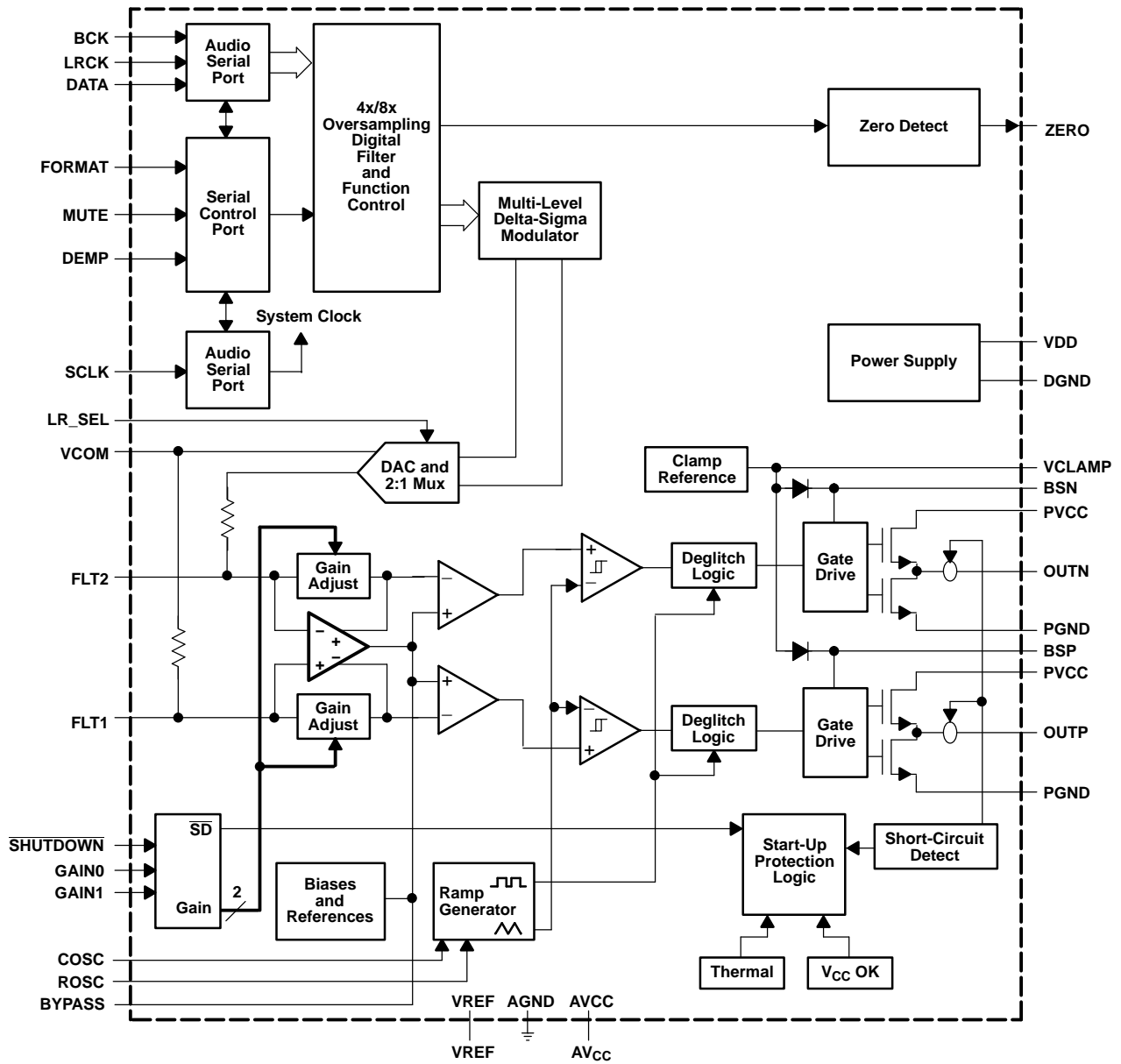

DCP
(TOP VIEW)

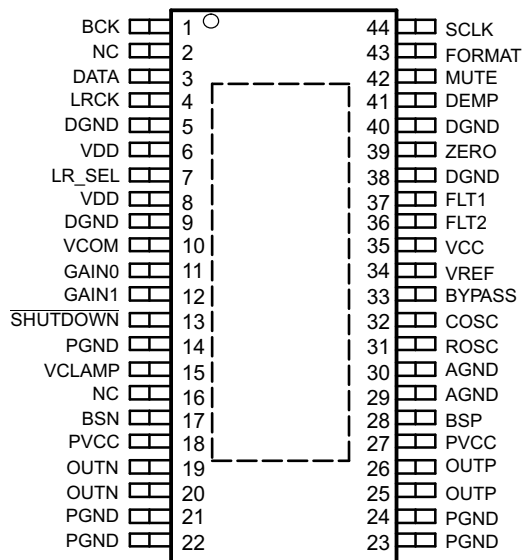

Terminal Functions

TERMINAL		I/O	DESCRIPTION
NO.	NAME		
1	BCK	I	Bit clock input for audio data
3	DATA	I	Audio data input
4	LRCK	I	Left and right channel audio data latch enable input
7	LR_SEL	I	Select left-channel or right-channel data HIGH: Left channel active LOW: Right channel active
11	GAIN0	I	Gain select least significant bit. TTL logic levels with compliance to 5 V.
12	GAIN1	I	Gain select most significant bit. TTL logic levels with compliance to 5 V.
13	SHUTDOWN	I	Shutdown signal for IC (low = shutdown, high = operational). TTL logic levels with compliance to 18 V.
5, 9, 38, 40	DGND	-	Digital ground
6, 8	VDD	-	Digital power supply (4.5 V – 5.5 V)
15	VCLAMP	-	Internally generated voltage supply for bootstrap capacitor
17	BSN	I/O	Bootstrap I/O, negative high-side FET
28	BSP	I/O	Bootstrap I/O, positive high-side FET
2, 16	NC	-	No internal connection
31	ROSC	I/O	I/O for current setting resistor for ramp generator
32	COSC	I/O	I/O for charge/discharging currents onto capacitor for ramp generator creation
33	BYPASS	O	Midrail analog reference voltage
34	VREF	O	Analog 5-V regulated output. Not to be used for powering external circuitry.
35	VCC	-	High-voltage analog power supply (8 V to 18 V).
19, 20	OUTN	O	Class-D 1/2-H-bridge negative output
39	ZERO	O	Zero flag output HIGH: No input present LOW: Data present at input This can be used to shutdown the device when no data is present at input.
41	DEMP	I	De-emphasis control. HIGH: 44.1 kHz De-emphasis ON LOW: 44.1 kHz De-emphasis OFF
42	MUTE	I	Soft mute control HIGH: Mute ON LOW: Mute OFF
43	FORMAT	I	Audio data format select HIGH: 16-bit right justified LOW: 16- to 24-bit, I ² S format
44	SCLK	I	System clock input
18, 27	PVCC	-	Power supply for H-bridge (8 V to 18 V)
25, 26	OUTP	O	Class-D 1/2-H-bridge positive output
29, 30	AGND	-	Analog ground
14, 21, 22, 23, 24	PGND	-	Power ground for H-bridge
10	VCOM	-	Midrail digital reference voltage
36	FLT2	I/O	Noise-filter terminals. Connect capacitor across pins 36 and 37
37	FLT1	I/O	
	Thermal Pad		Connect to AGND and PGND - should be the center point for both grounds. Internal resistive connection to AGND.

TYPICAL CHARACTERISTICS

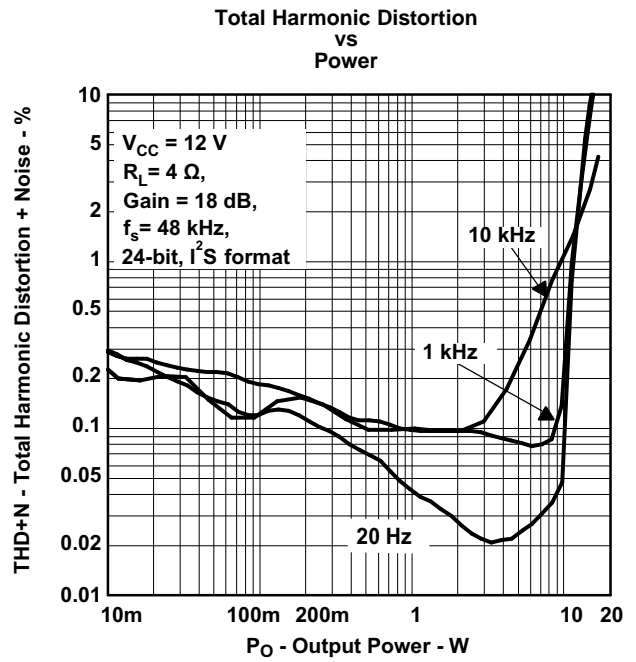
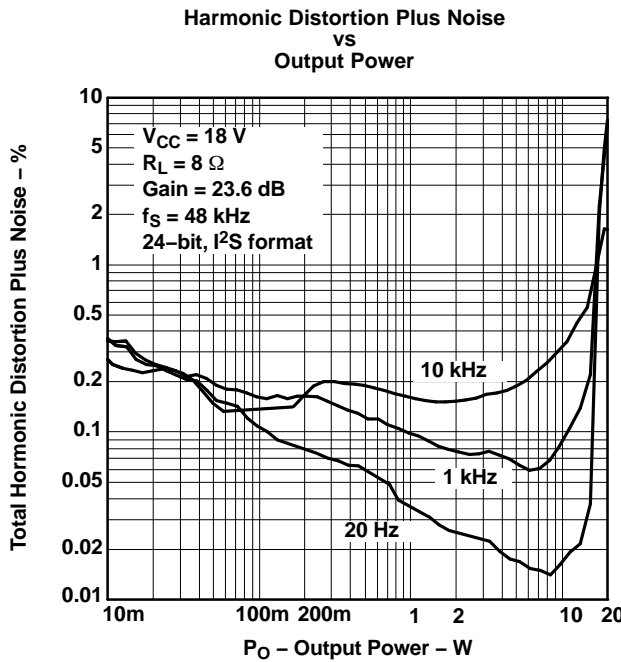
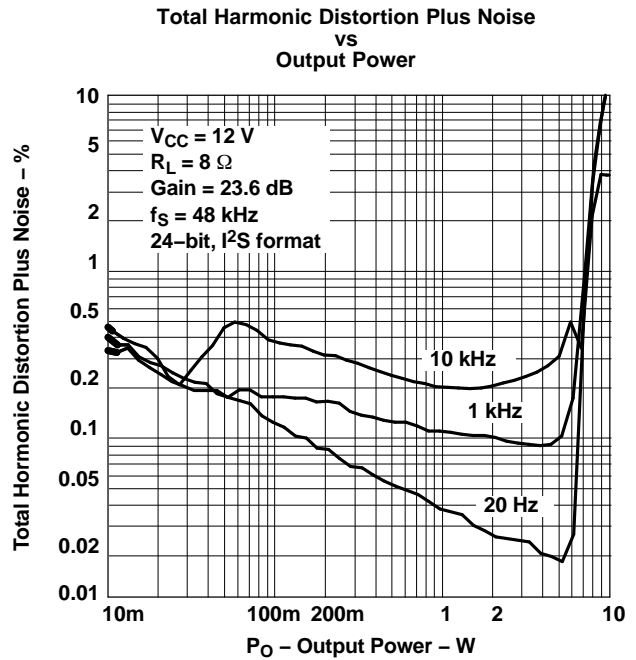
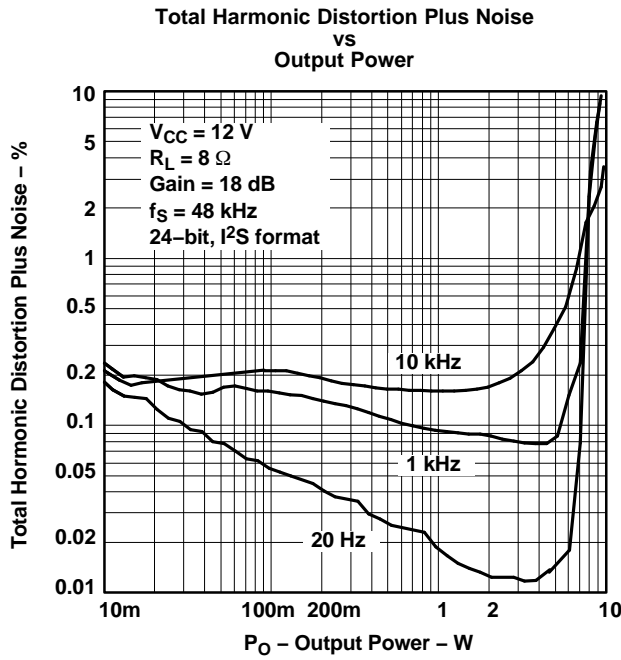

TYPICAL CHARACTERISTICS (continued)

**Total Harmonic Distortion Plus Noise
vs
Frequency**

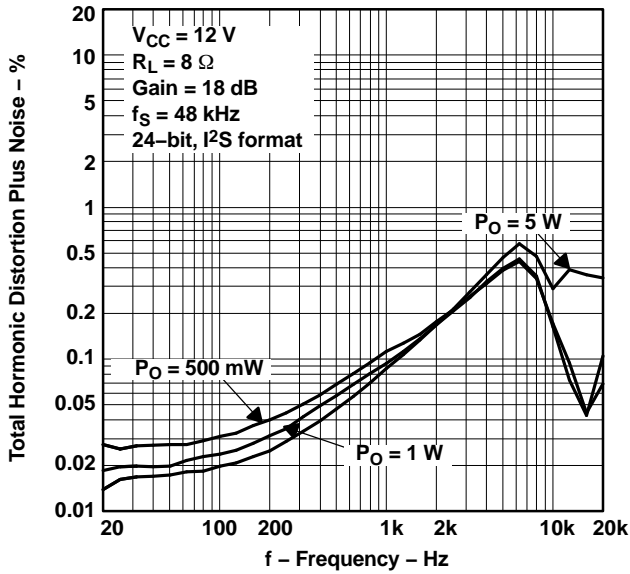

Figure 5.

**Total Harmonic Distortion Plus Noise
vs
Frequency**

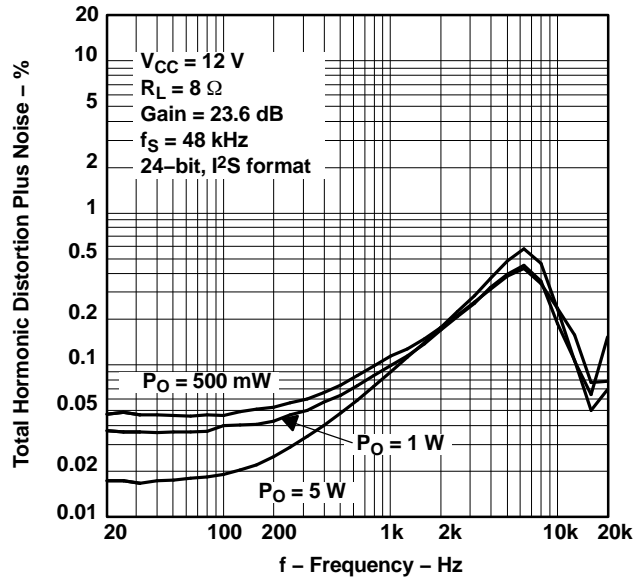

Figure 6.

**Total Harmonic Distortion Plus Noise
vs
Frequency**

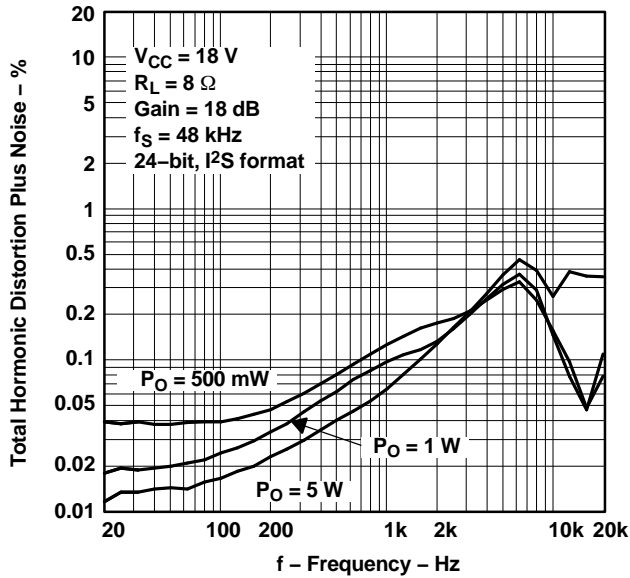

Figure 7.

**Total Harmonic Distortion Plus Noise
vs
Frequency**

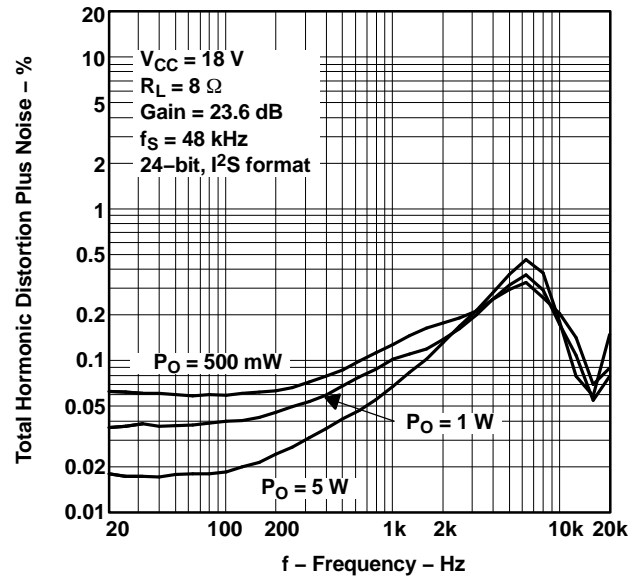

Figure 8.

TYPICAL CHARACTERISTICS (continued)

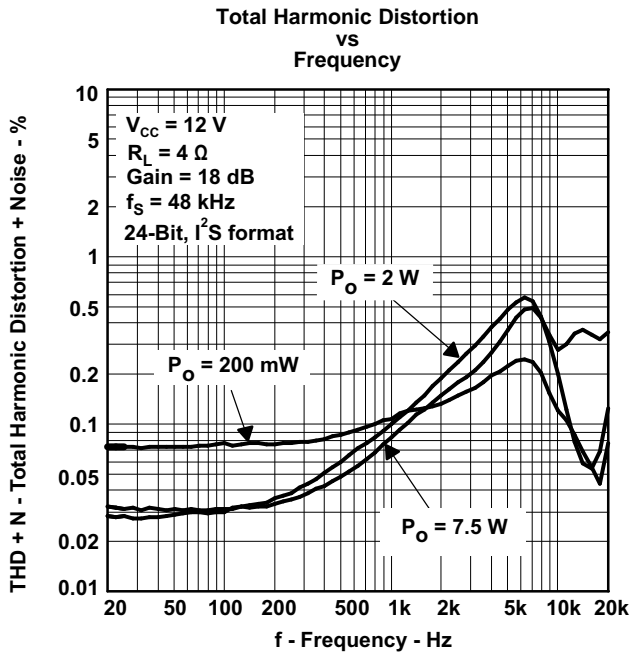

Figure 9.

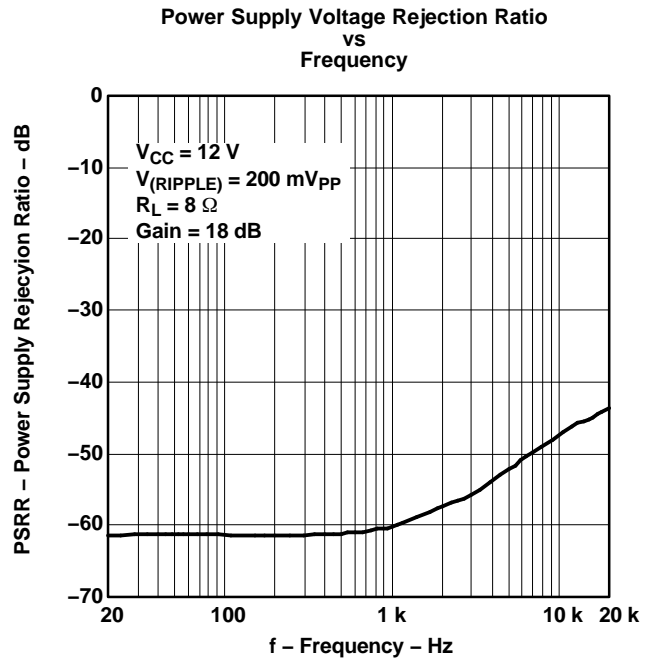

Figure 10.

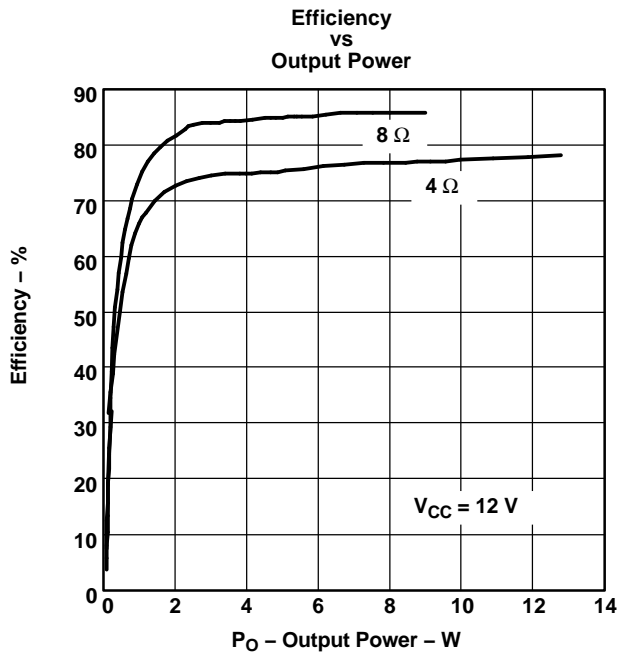

Figure 11.

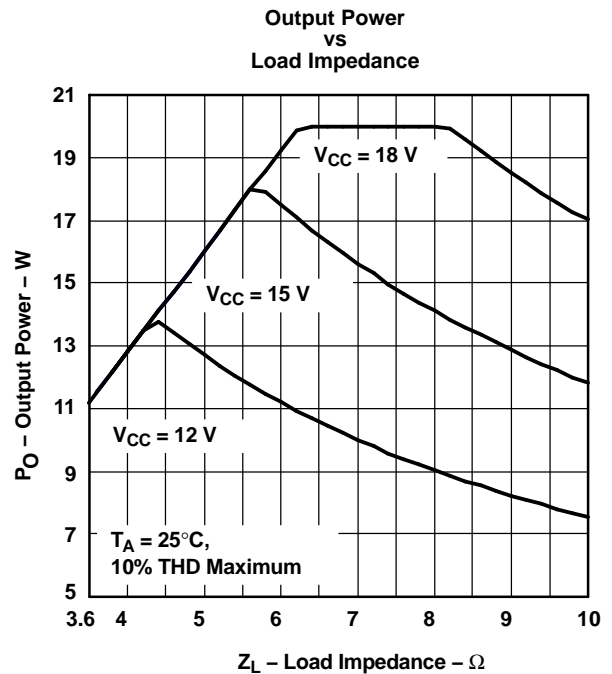

Figure 12.

TYPICAL CHARACTERISTICS (continued)

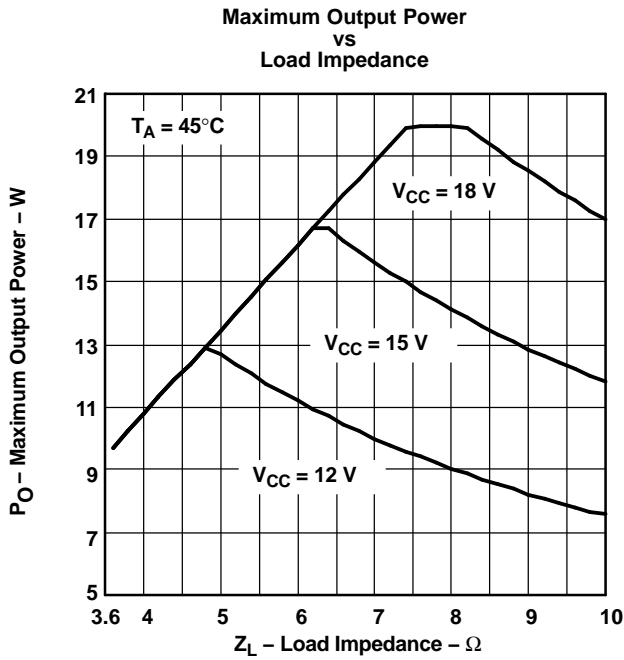

Figure 13.

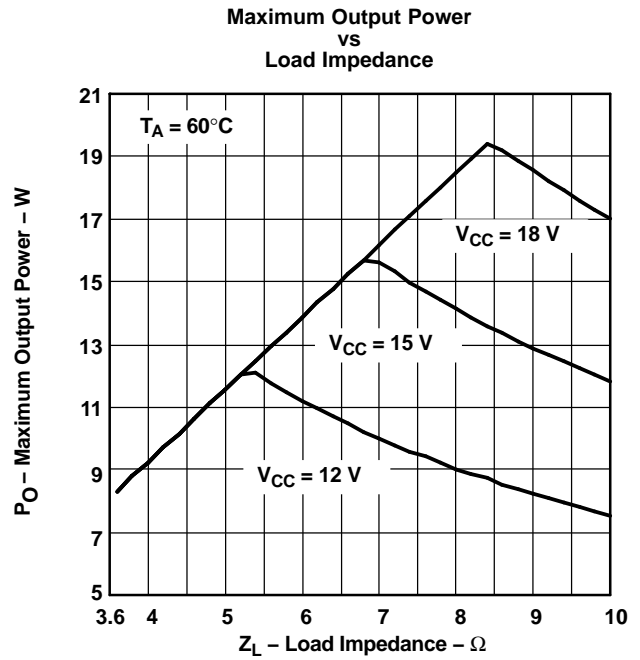

Figure 14.

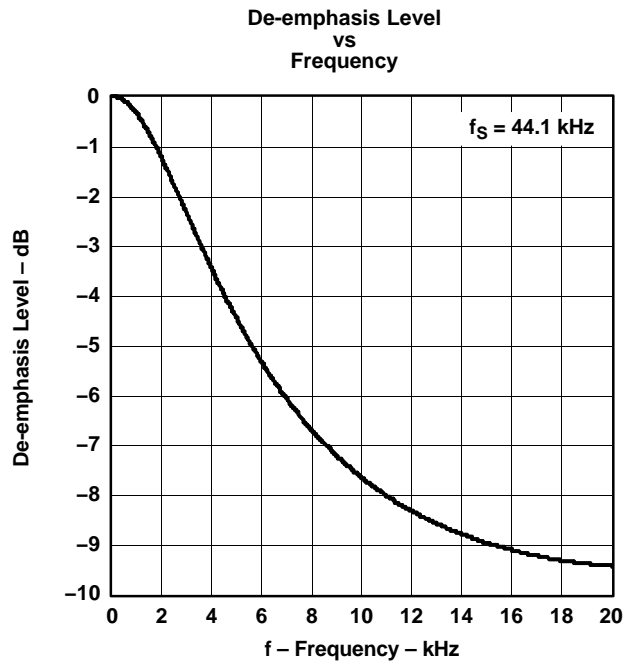

Figure 15.

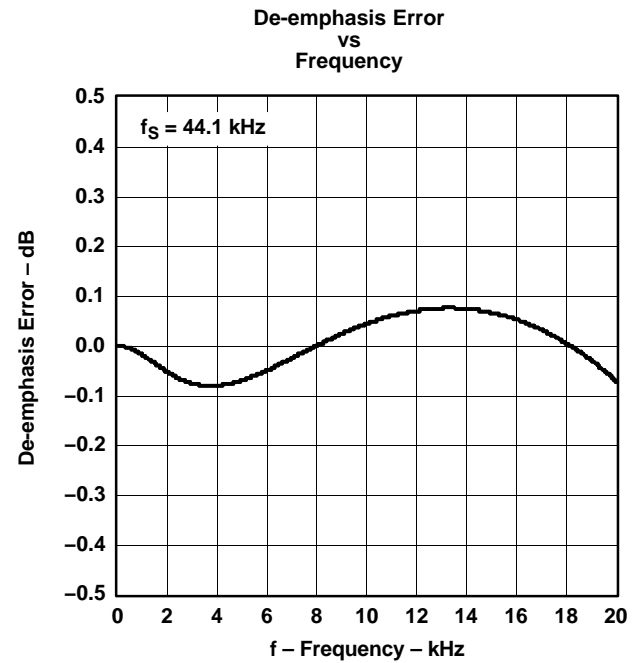

Figure 16.

APPLICATION INFORMATION

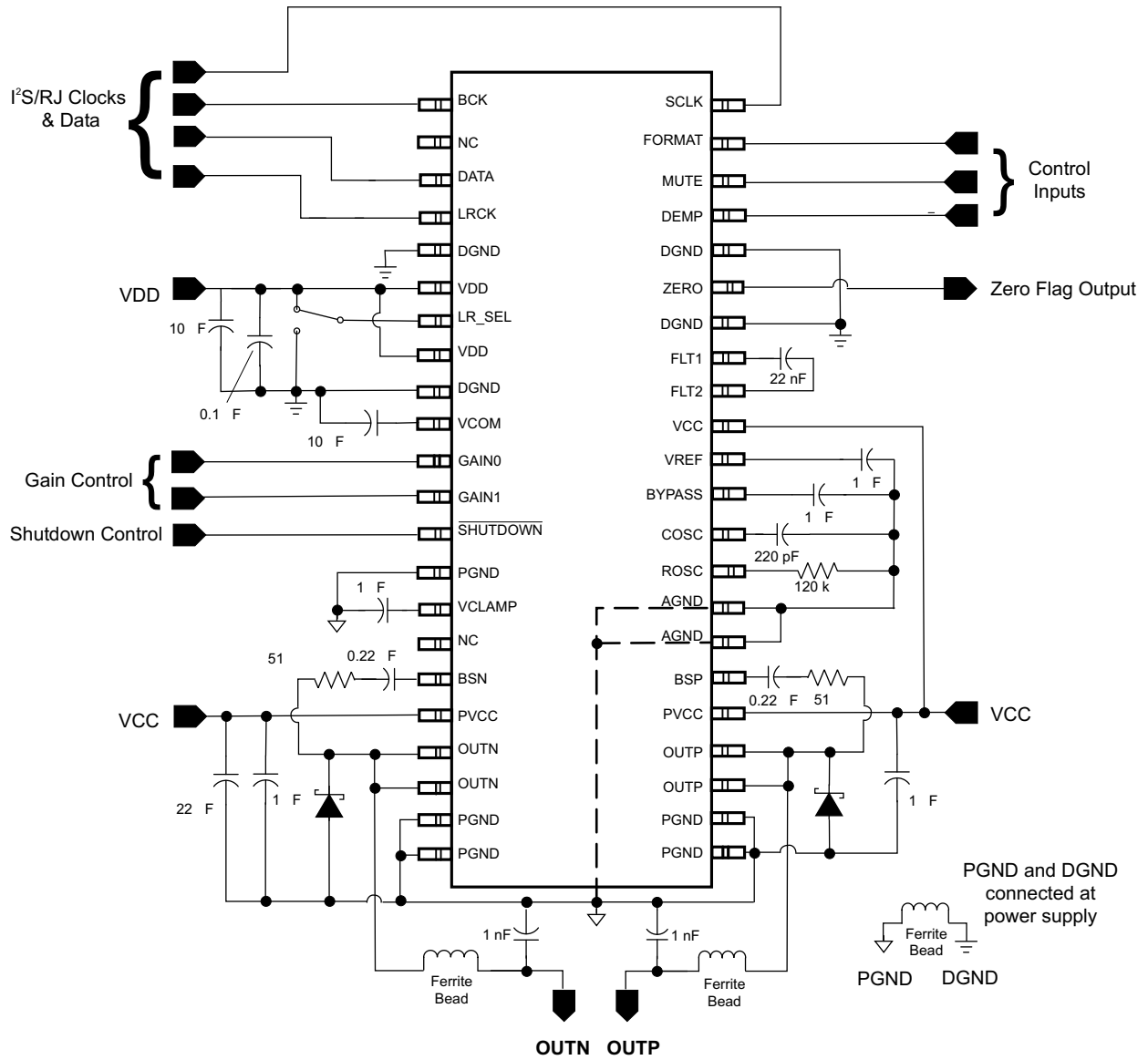

Figure 17. Typical Application Circuit

APPLICATION INFORMATION (continued)

SYSTEM CLOCK INPUT

The TPA3200D1 requires a system clock for operating the digital interpolation filters and multilevel delta-sigma modulators. The system clock is applied at the SCLK input (pin 44). Table 1 shows examples of system clock frequencies for common audio sampling rates.

Figure 18 shows the timing requirements for the system clock input. For optimal performance, it is important to use a clock source with low phase-jitter and noise. TI's PLL170x family of multiclock generators is an excellent choice for providing the TPA3200D1 system clock.

Table 1. System Clock Rates for Common Audio Sampling Frequencies

SAMPLE FREQUENCY	SYSTEM CLOCK FREQUENCY (f_{SCLK}) (MHz)						
	$128 f_s$	$192 f_s$	$256 f_s$	$384 f_s$	$512 f_s$	$768 f_s$	$1152 f_s$
8 kHz	1.0240	1.5360	2.0480	3.0720	4.0960	6.1440	9.2160
16 kHz	2.0480	3.0720	4.0960	6.1440	8.1920	12.2880	18.4320
32 kHz	4.0960	6.1440	8.1920	12.2880	16.3840	24.5760	36.8640
44.1 kHz	5.6448	8.4672	11.2896	16.9344	22.5792	33.8688	(1)
48 kHz	6.1440	9.2160	12.2880	18.4320	24.5760	36.8640	(1)
88.2 kHz	11.2896	16.9344	22.5792	33.8688	45.1584	(1)	(1)
96 kHz	12.2880	18.4320	24.5760	36.8640	49.1520	(1)	(1)
192 kHz	24.5760	36.8640	49.1520	See (1)	(1)	(1)	(1)

(1) This system clock rate is not supported for the given sampling frequency.

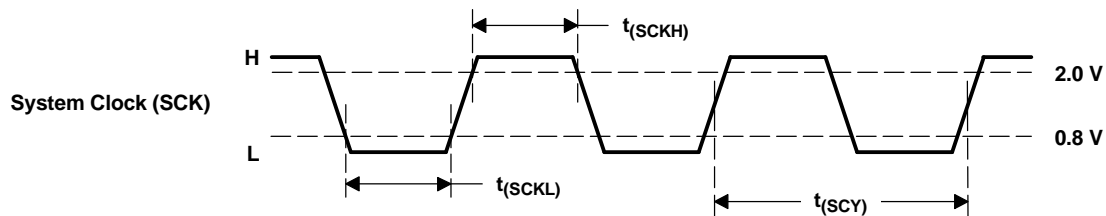

Figure 18. System Clock Input Timing

PARAMETERS	SYMBOL	MIN	TYP	MAX	UNITS
System clock pulse duration, high	$t_{(SCKH)}$	7			ns
System clock pulse duration, low	$t_{(SCKL)}$				
System clock pulse cycle time	$t_{(SCY)}$	7	See (1)		

(1) $1/128 f_s$, $1/256 f_s$, $1/384 f_s$, $1/512 f_s$, $1/768 f_s$, or $1/1152 f_s$

AUDIO SERIAL INTERFACE

The audio serial interface for the TPA3200D1 consists of a 3-wire synchronous serial port. It includes LRCK (pin 4), BCK (pin 1), and DATA (pin 3). BCK is the serial audio bit clock, and it is used to clock the serial data present on DATA into the serial shift register of the audio interface. Serial data is clocked into the TPA3200D1 on the rising edge of BCK. LRCK is the serial audio left/right word clock. It is used to latch serial data into the internal registers of the serial audio interface.

Both LRCK and BCK should be synchronous to the system clock. Ideally, it is recommended that LRCK and BCK be derived from the system clock input, SCK. LRCK is operated at the sampling frequency, f_s . BCK can be operated at 32, 48, or 64 times the sampling frequency for standard and left-justified formats. BCK can be operated at 48 or 64 times the sampling frequency for the I²S format.

Internal operation of the TPA3200D1 is synchronized with LRCK. Accordingly, internal operation is held when the sampling rate clock of LRCK is changed or when SCK and/or BCK is interrupted for a 3-bit clock cycle or longer. If SCK, BCK, and LRCK are provided continuously after this held condition, the internal operation is re-synchronized automatically in a period of less than $3/f_s$. External resetting is not required.

AUDIO DATA FORMATS AND TIMING

The TPA3200D1 supports I²S and 16-bit-word right-justified. The data formats are shown in Figure 20. Data formats are selected using the FORMAT pin on the TPA3200D1. All formats require binary 2s-complement, MSB-first audio data. Figure 19 shows a detailed timing diagram for the serial audio interface.

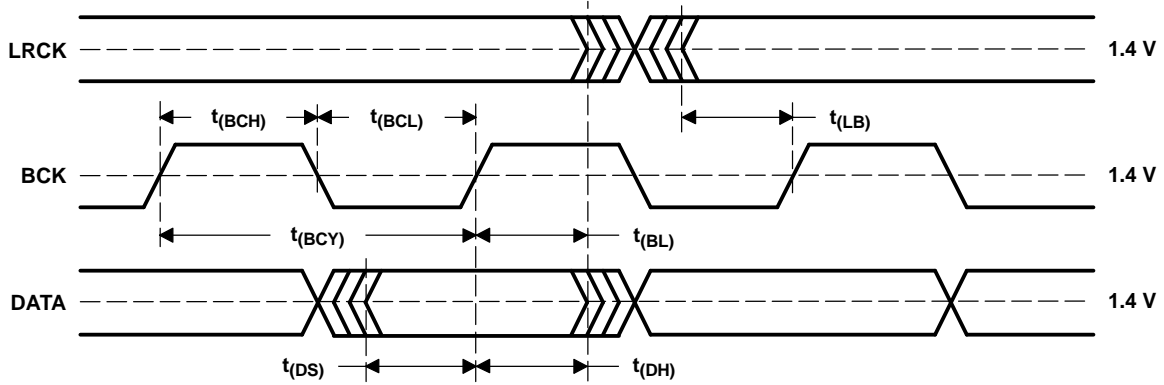
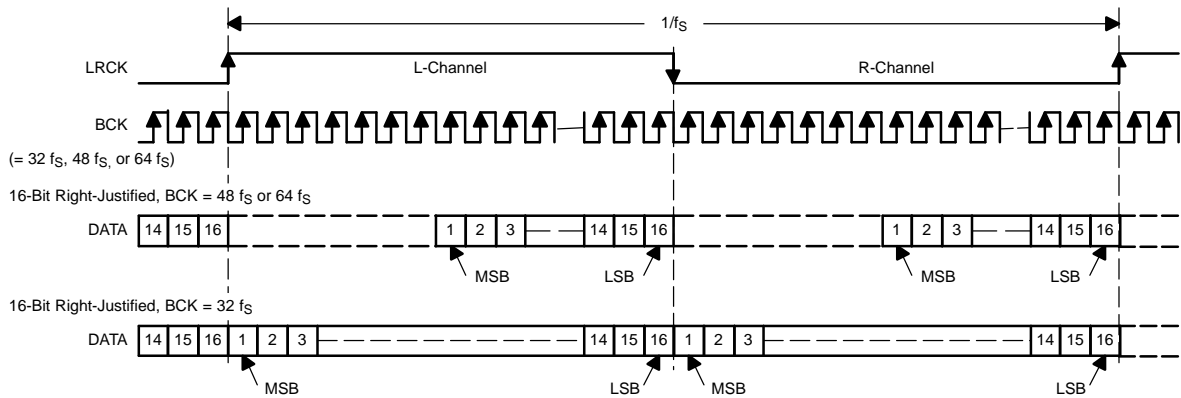

Figure 19. Audio Interface Timing

PARAMETERS	SYMBOL	MIN	TYP	MAX	UNITS
BCK pulse cycle time	$t_{(BCY)}$	$1/(32 f_s), 1/(48 f_s), 1/(64 f_s)^{(1)}$			ns
BCK high-level time	$t_{(BCH)}$	35			
BCK low-level time	$t_{(BCL)}$	35			
BCK rising edge to LRCK edge	$t_{(BL)}$	10			
LRCK falling edge to BCK rising edge	$t_{(LB)}$	10			
DATA setup time	$t_{(DS)}$	10			
DATA hold time	$t_{(DH)}$	10			

(1) f_s is the sampling frequency (e.g., 44.1 kHz, 48 kHz, 96 kHz, etc.).

(1) 16-Bit-Word Right Justified



(2) I²S Data Format; L-Channel = LOW, R-Channel = HIGH

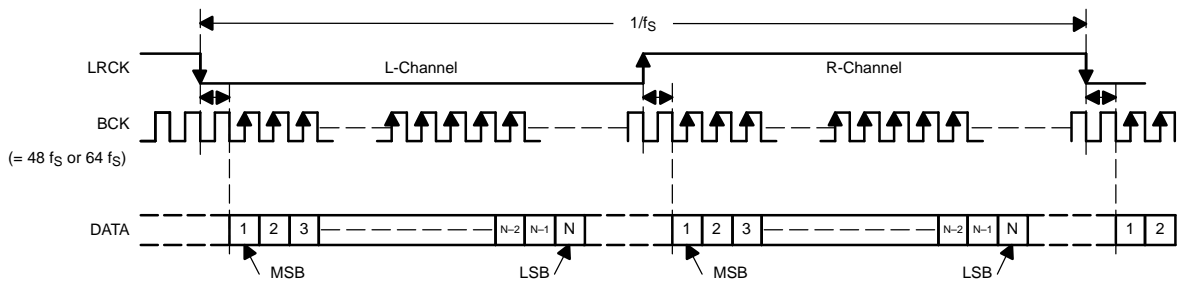

Figure 20. Audio Data Input Formats

ZERO FLAG

ZERO (pin 39) is the L-channel and R-channel common zero flag pin. If the data for L-channel and R-channel remains at a 0 level for 1024 sampling periods (or LRCK clock periods), the ZERO flag output is set to a logic 1 state.

The ZERO-pin output can be inverted using a standard logic gate or transistor, and connected to the SHUTDOWN terminal (pin 13). This places the TPA3200D1 into a low-current state, conserving power, and disables the switching outputs.

REGISTER CONTROL

The digital functions of the TPA3200D1 are controlled by 4 terminals. [Table 2](#) shows selectable data formats, [Table 3](#) shows de-emphasis control, [Table 4](#) shows mute control, and [Table 5](#) shows channel-output select.

Table 2. Data Format Select

FMT (PIN 43)	DATA FORMAT
LOW	16- to 24-bit, I ² S format
HIGH	16-bit right-justified

Table 3. De-Emphasis Control

DEMP (PIN 41)	DE-EMPHASIS FUNCTION
LOW	44.1 kHz de-emphasis OFF
HIGH	44.1 kHz de-emphasis ON

Table 4. Mute Control

MUTE (PIN 42)	MUTE
LOW	Mute OFF
HIGH	Mute ON

Table 5. Channel Output Select

LR_SEL (PIN 7)	ACTIVE CHANNEL ⁽¹⁾
LOW	Right
HIGH	Left

- (1) A digital data stream consists of two channels of data. In an I²S or right-justified data stream, the left-channel data precedes the right-channel data (See [Figure 20](#)). The LR_SEL input selects the channel to send to the mono output.

OVERSAMPLING RATE CONTROL

The TPA3200D1 automatically controls the oversampling rate of the delta-sigma D/A converters with the system clock rate. The oversampling rate is set to 64x oversampling with every system clock and sampling frequency.

VCOM OUTPUT

One unbuffered common-mode voltage output pin, VCOM (pin 10) is brought out for decoupling purposes. This pin is nominally biased to a dc voltage level equal to $0.5 \times V_{DD}$. This pin cannot be used to bias external circuits.

CLASS-D OPERATION

This section focuses on the class-D operation of the TPA3200D1.

Traditional Class-D Modulation Scheme

The traditional class-D modulation scheme, which is used in the TPA032D0x family, has a differential output where each output is 180 degrees out of phase and changes from ground to the supply voltage, V_{CC} . Therefore, the differential pre-filtered output varies between positive and negative V_{CC} , where filtered 50% duty cycle yields 0 V across the load. The traditional class-D modulation scheme with voltage and current waveforms is shown in Figure 31. Note that even at an average of 0 V across the load (50% duty cycle), the current to the load is high, causing high loss, thus causing a high supply current.

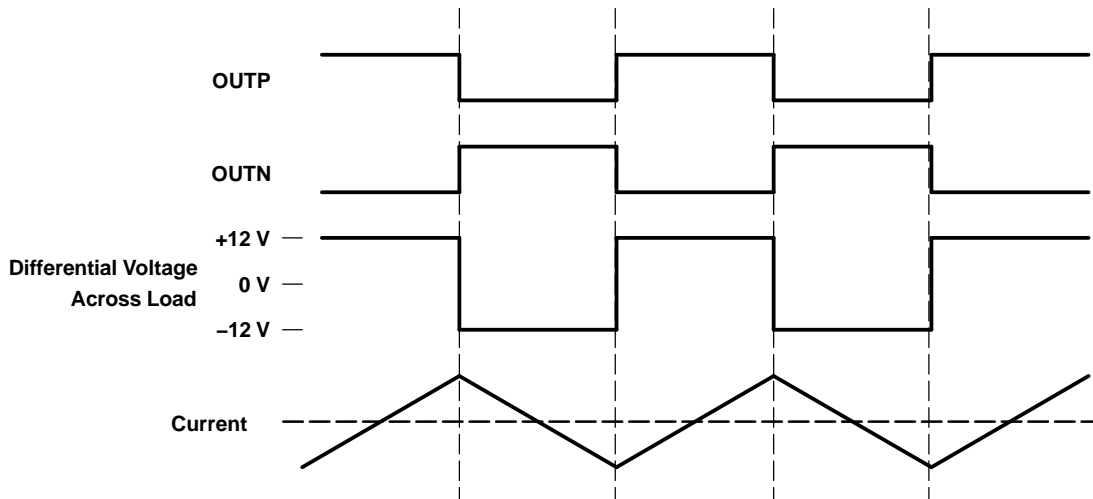

Figure 21. Traditional Class-D Modulation Scheme's Output Voltage and Current Waveforms Into an Inductive Load With No Input

TPA3200D1 Modulation Scheme

The TPA3200D1 uses a modulation scheme that still has each output switching from ground to V_{CC} . However, OUTP and OUTN are now in phase with each other with no input. The duty cycle of OUTP is greater than 50% and OUTN is less than 50% for positive output voltages. The duty cycle of OUTP is less than 50% and OUTN is greater than 50% for negative output voltages. The voltage across the load is 0 V throughout most of the switching period, greatly reducing the switching current, which reduces any I^2R losses in the load. (See [Figure 22](#).)

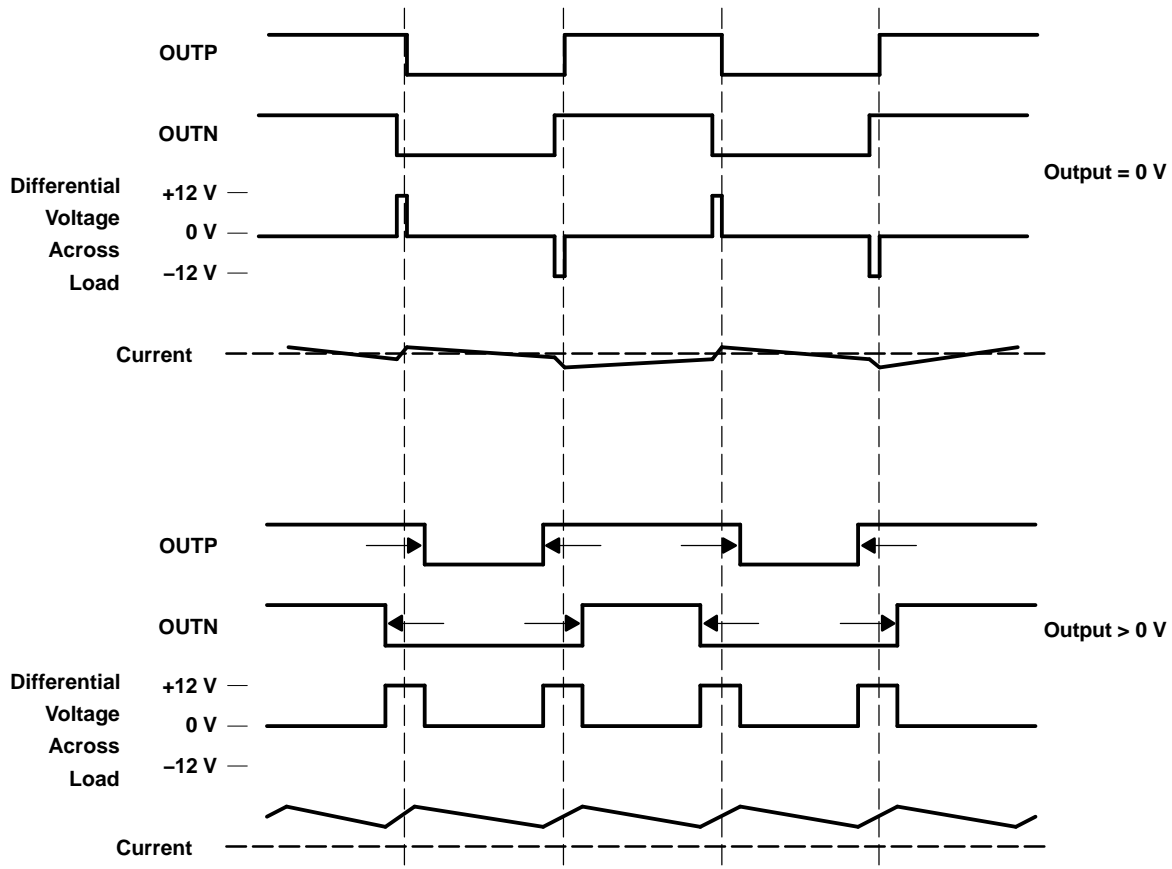
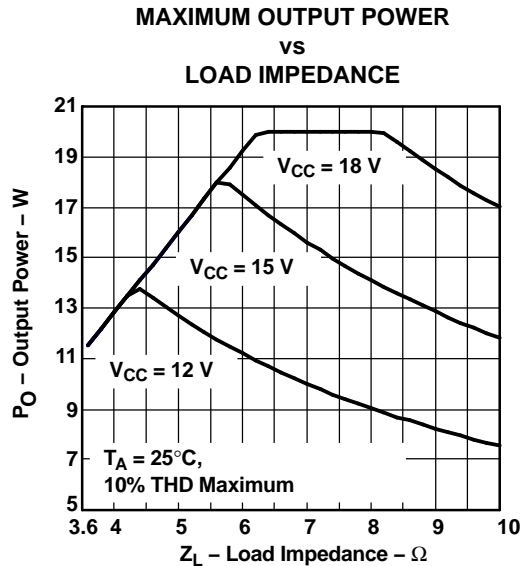

Figure 22. The TPA3200D1 Output Voltage and Current Waveforms Into an Inductive Load

Maximum Allowable Output Power (Safe Operating Area)

The TPA3200D1 can drive load impedances as low as 3.6 Ω from power supply voltages ranging from 8 V to 18 V. To prevent device failure, however, the output power of the TPA3200D1 must be limited. Figure 23 shows the maximum allowable output power versus load impedance for three power supply voltages at an ambient temperature of 25°C.



Driving The Output Into Clipping

The output of the TPA3200D1 may be driven into clipping to attain a higher output power than is possible with no distortion. Clipping is typically quantified by a THD measurement of 10%. The amount of additional power into the load may be calculated with Equation 1.

$$P_{O(10\% \text{ THD})} = P_{O(1\% \text{ THD})} \times 1.25 \quad (1)$$

For example, consider an application in which the TPA3200D1 drives an 8-Ω speaker from an 18-V power supply. The maximum output power with no distortion (less than 1% THD) is 16 W, which corresponds to a maximum peak output voltage of 16 V. For the same output voltage level driven into clipping (10% THD), the output power is increased to 20 W.

Output Filter Considerations

A ferrite bead filter (shown in Figure 24) should be used in order to pass FCC and/or CE radiated emissions specifications and if a frequency sensitive circuit operating higher than 1 MHz is nearby. The ferrite filter reduces EMI around 1 MHz and higher (FCC and CE only test radiated emissions greater than 30 MHz). When selecting a ferrite bead, choose one with high impedance at high frequencies, but very low impedance at low frequencies.

Use an additional LC output filter if there are low frequency (<1 MHz) EMI sensitive circuits and/or there are long wires (greater than 11 inches) from the amplifier to the speaker, as shown in Figure 25 and Figure 26.

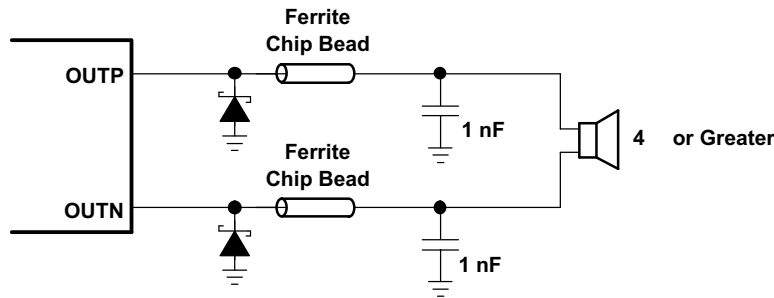

Figure 24. Typical Ferrite Chip Bead Filter (Chip bead example: Fair-Rite 2512067007Y3)

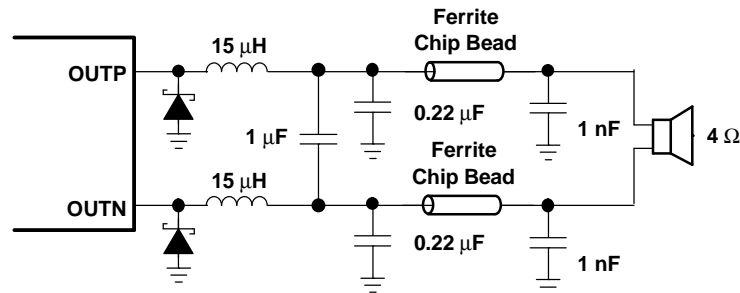

Figure 25. Typical LC Output Filter for 4-Ω Speaker, Cutoff Frequency of 41 kHz

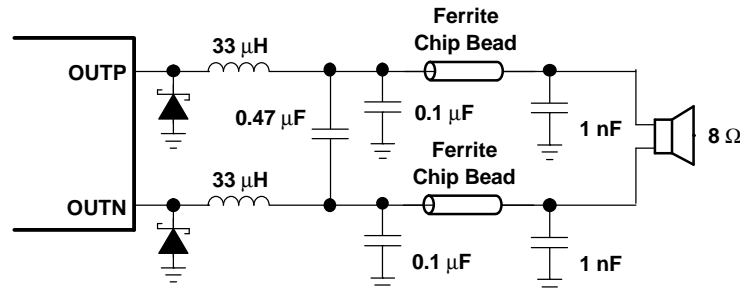

Figure 26. Typical LC Output Filter for 8-Ω Speaker, Cutoff Frequency of 41 kHz

SHORT-CIRCUIT PROTECTION

The TPA3200D1 has short circuit protection circuitry on the outputs that prevents damage to the device during output-to-output shorts, output-to-GND shorts, and output-to- V_{CC} shorts. When a short-circuit is detected on the outputs, the part immediately disables the output drive and enters into shutdown mode. This is a latched fault and must be reset by cycling the voltage on the SHUTDOWN pin to a logic low and back to the logic high state for normal operation. This will clear the short-circuit flag and allow for normal operation if the short was removed. If the short was not removed, the protection circuitry will again activate.

Two Schottky diodes are required to provide short-circuit protection. The diodes should be placed as close to the TPA3200D1 as possible, with the anodes connected to PGND and the cathodes connected to OUTP and OUTN as shown in the application circuit schematic. The diodes should have a forward voltage rating of 0.5 V at a minimum of 1 A output current and a dc blocking voltage rating of at least 30 V. The diodes must also be rated to operate at a junction temperature of 150°C.

If short-circuit protection is not required, the Schottky diodes may be omitted.

THERMAL PROTECTION

Thermal protection on the TPA3200D1 prevents damage to the device when the internal die temperature exceeds 150°C. There is a ±15°C tolerance on this trip point from device to device. Once the die temperature exceeds the thermal set point, the device enters into the shutdown state and the outputs are disabled. This is not a latched fault. The thermal fault is cleared once the temperature of the die is reduced by 15°C. The device begins normal operation at this point with no external system interaction.

THERMAL CONSIDERATIONS: OUTPUT POWER AND MAXIMUM AMBIENT TEMPERATURE

To calculate the maximum ambient temperature, [Equation 2](#) is used:

$$T_{Amax} = T_{Jmax} - \theta_{JA} P_{Dissipated}$$

where : $T_{Jmax} = 150^{\circ}\text{C}$

$$\theta_{JA} = \frac{1}{\text{derating factor}} = \frac{1}{0.0391} = 25.6^{\circ}\text{C}$$
(2)

The derating factor for the 44-pin DCP package is given in the dissipation rating table.

To estimate the power dissipation, [Equation 3](#) is used:

$$P_{Dissipated} = P_{O(average)} \times \left(\frac{1}{\text{Efficiency}} - 1 \right)$$

Efficiency = ~ 75% for an 4-Ω load

Efficiency = ~ 85% for an 8-Ω load

(3)

Example. What is the maximum ambient temperature for an application that requires the TPA3200D1 to drive 20 W into an 8-Ω speaker?

$$P_{Dissipated} = 20 \text{ W} \times \left(\frac{1}{0.85} - 1 \right) = 3.53 \text{ W}$$

$$T_{Amax} = 150^{\circ}\text{C} - (25.6^{\circ}\text{C/W} \times 1.76 \text{ W}) = 59.6^{\circ}\text{C}$$
(4)

This calculation shows that the TPA3200D1 can drive 20 W of RMS power into an 8-Ω speaker up to a maximum ambient temperature rating of 60°C.

GAIN SETTING VIA GAIN0 AND GAIN1 INPUTS

The gain of the TPA3200D1 is set by two input terminals, GAIN0 and GAIN1. See [Table 6](#).

Table 6. Gain Settings

GAIN1	GAIN0	AMPLIFIER GAIN (dB)	Output Voltage with Full Scale Input and $V_{DD}=5 \text{ V}$ (V_{RMS})
		TYP	TYP
0	0	12	5.63
0	1	18	11.23
1	0	23.6	21.4 ⁽¹⁾
1	1	Reserved	Reserved

(1) Output clipping with $V_{CC} = 18 \text{ V}$

The typical output voltage, measured across the load, is also given in [Table 6](#) at each of the gain steps. This is the expected voltage with a full scale input signal applied at the digital inputs and $V_{DD} = 5\text{ V}$. This voltage scales proportionally with a lower or higher V_{DD} . For example, if $V_{DD} = 4.5\text{ V}$, scale the results in [Table 6](#) by 4.5/5, or 0.9.

The differential offset voltage, measured across the speaker outputs, increases as the gain is increased. For the lowest offset voltage, specified in the electrical characteristics table, set the gain at the lowest step, 12 dB.

POWER SUPPLY DECOUPLING

The TPA3200D1 is a high-performance CMOS audio amplifier that requires adequate power supply decoupling to ensure the output total harmonic distortion (THD) is as low as possible. Power supply decoupling also prevents oscillations for long lead lengths between the amplifier and the speaker. The optimum decoupling is achieved by using two capacitors of different types that target different types of noise on the power supply leads. For higher frequency transients, spikes, or digital hash on the line, a good low equivalent-series-resistance (ESR) ceramic capacitor, typically 1 μF placed as close as possible to the device V_{CC} lead works best. For filtering lower-frequency noise signals, a larger aluminum electrolytic capacitor of 10 μF or greater placed near the audio power amplifier is recommended.

BSN AND BSP CAPACITORS

The full H-bridge output stage uses only NMOS transistors. It therefore requires bootstrap capacitors for the high side of each output to turn on correctly. A 0.22- μF ceramic capacitor, rated for at least 25 V, must be connected from each output to its corresponding bootstrap input. Specifically, one 0.22- μF capacitor must be connected from OUTP to BSP, and one 0.22- μF capacitor must be connected from OUTN to BSN.

BSN AND BSP RESISTORS

To limit the current when charging the bootstrap capacitors, a resistor with a value of approximately 50 Ω (+/-10% maximum) must be placed in series with each bootstrap capacitor. The current will be limited to less than 500 μA .

VCLAMP CAPACITOR

To ensure that the maximum gate-to-source voltage for the NMOS output transistors is not exceeded, an internal regulator clamps the gate voltage. A 1- μF capacitor must be connected from VCLAMP (pin 15) to ground. This capacitor must have a rating of V_{CC} or more. The voltage at VCLAMP (pin 15) varies with V_{CC} and may not be used for powering any other circuitry.

MIDRAIL BYPASS CAPACITOR

The midrail bypass capacitor is the most critical capacitor and serves several important functions. During start-up or recovery from shutdown mode, $C_{(BYPASS)}$ determines the rate at which the amplifier starts up. The second function is to reduce noise produced by the power supply caused by coupling into the output drive signal. This noise is from the midrail generation circuit internal to the amplifier, which appears as degraded PSRR and THD+N.

VREF DECOUPLING CAPACITOR

The VREF terminal (pin 34) is the output of an internally-generated 5-V supply, used for the oscillator and gain setting logic. It requires a 0.1- μF to 1- μF capacitor to ground to keep the regulator stable. The regulator may not be used to power any additional circuitry.

SWITCHING FREQUENCY

The switching frequency is determined using the values of the components connected to ROSC (pin 31) and COSC (pin 32) and may be calculated using [Equation 5](#):

$$f_s = \frac{6.6}{R_{OSC} C_{OSC}} \quad (5)$$

The frequency may be varied from 225 kHz to 275 kHz by adjusting the values chosen for ROSC and COSC.

SHUTDOWN OPERATION

The TPA3200D1 employs a shutdown mode of operation designed to reduce supply current (I_{CC}) to the absolute minimum level during periods of non-use for battery-power conservation. The $\overline{\text{SHUTDOWN}}$ input terminal should be held high during normal operation when the amplifier is in use. Pulling $\overline{\text{SHUTDOWN}}$ low causes the outputs to mute and the amplifier to enter a low-current state, $I_{CC(\text{SD})} = 1 \mu\text{A}$. $\overline{\text{SHUTDOWN}}$ should never be left unconnected, because amplifier operation would be unpredictable.

Ideally, the device should be held in shutdown when the system powers up and brought out of shutdown once any digital circuitry has settled. However, if $\overline{\text{SHUTDOWN}}$ is to be left unused, the terminal may be connected directly to V_{CC} .

USING LOW-ESR CAPACITORS

Low-ESR capacitors are recommended throughout this application section. A real (as opposed to ideal) capacitor can be modeled simply as a resistor in series with an ideal capacitor. The voltage drop across this resistor minimizes the beneficial effects of the capacitor in the circuit. The lower the equivalent value of this resistance the more the real capacitor behaves like an ideal capacitor.

A metalized polyester capacitor is recommended for the capacitor placed in parallel across the FLT1 and FLT2 inputs. This ensures the best noise performance.

PRINTED-CIRCUIT BOARD (PCB) LAYOUT

Because the TPA3200D1 is a class-D amplifier that switches at a high frequency, the layout of the printed-circuit board (PCB) should be optimized according to the following guidelines for the best possible performance.

- Decoupling capacitors — The high-frequency 1- μF decoupling capacitors should be placed as close to the PVCC (pin 18 and pin 27) and VCC (pin 35) terminals as possible. The BYPASS (pin 33) capacitor, VREF (pin 34) capacitor, and VCLAMP (pin 15) capacitor should also be placed as close to the device as possible. The large (10 μF or greater) bulk power supply decoupling capacitor should be placed near the TPA3200D1 at the PVCC terminals.
- Grounding — The VCC (pin 35) decoupling capacitor, VREF (pin 34) capacitor, BYPASS (pin 33) capacitor, COSC (pin 32) capacitor, and ROsc (pin 31) resistor should each be grounded to analog ground (AGND, pin 29 and pin 30). The PVCC (pin 18 and pin 27) decoupling capacitors should each be grounded to power ground (PGND pins 14, 21, 22, 23, and 24). Analog ground and power ground may be connected at the PowerPAD, which should be used as a central ground connection, or star ground, for the TPA3200D1. DGND (pins 5, 9, 38, and 40) should be connected to PGND, and AGND at the power supply through a ferrite bead. Connect the VDD (pins 6 and 8) decoupling capacitor to DGND. This pattern separates the digital power-switching currents and digital input currents, and prevents interference between them.
- Digital input signal routing — The SCLK, BCK, LRCK, and DATA input are sensitive, high-frequency signals that should be shielded by a clean GND layer to avoid interference. For a 2-layer PCB, shield the signals on the bottom layer with a plane connected to DGND. On the top layer, route DGND closely around these signals.
- Output filter — The ferrite filter ([Figure 24](#)) should be placed as close to the output terminals (pins 19, 20, 25, and 26) as possible for the best EMI performance. The LC filter ([Figure 25](#) and [Figure 26](#)) should be placed closest to the output and followed by a ferrite-bead filter. The capacitors used in both the ferrite and LC filters should be grounded to power ground.
- PowerPAD — The PowerPAD must be soldered to the PCB for proper thermal performance and optimal reliability. The dimensions of the PowerPAD thermal land on the PCB should be 3.5 mm by 9.5 mm. Three rows of solid vias (six vias per row, 0.3302 mm or 13 mils diameter) should be equally spaced underneath the thermal land. The vias should connect to a solid copper plane, either on an internal layer or on the bottom layer of the PCB. The vias must be solid vias, not thermal relief or webbed vias. For additional information, see the *PowerPAD Thermally Enhanced Package* technical brief, TI literature number [SLMA002](#).

For an example layout, see the *TPA3200D1 Evaluation Module (TPA3200D1EVM) User Manual*, TI literature number [SLOU173](#). Both the EVM user manual and the PowerPAD application note are available on the TI web site at <http://www.ti.com>.

PACKAGING INFORMATION

Orderable Device	Status (1)	Package Type	Package Drawing	Pins	Package Qty	Eco Plan (2)	Lead/Ball Finish (6)	MSL Peak Temp (3)	Op Temp (°C)	Device Marking (4/5)	Samples
TPA3200D1DCP	NRND	HTSSOP	DCP	44		TBD	Call TI	Call TI	-40 to 85	TPA3200D1	

(1) The marketing status values are defined as follows:

ACTIVE: Product device recommended for new designs.

LIFEBUY: TI has announced that the device will be discontinued, and a lifetime-buy period is in effect.

NRND: Not recommended for new designs. Device is in production to support existing customers, but TI does not recommend using this part in a new design.

PREVIEW: Device has been announced but is not in production. Samples may or may not be available.

OBSOLETE: TI has discontinued the production of the device.

(2) Eco Plan - The planned eco-friendly classification: Pb-Free (RoHS), Pb-Free (RoHS Exempt), or Green (RoHS & no Sb/Br) - please check <http://www.ti.com/productcontent> for the latest availability information and additional product content details.

TBD: The Pb-Free/Green conversion plan has not been defined.

Pb-Free (RoHS): TI's terms "Lead-Free" or "Pb-Free" mean semiconductor products that are compatible with the current RoHS requirements for all 6 substances, including the requirement that lead not exceed 0.1% by weight in homogeneous materials. Where designed to be soldered at high temperatures, TI Pb-Free products are suitable for use in specified lead-free processes.

Pb-Free (RoHS Exempt): This component has a RoHS exemption for either 1) lead-based flip-chip solder bumps used between the die and package, or 2) lead-based die adhesive used between the die and leadframe. The component is otherwise considered Pb-Free (RoHS compatible) as defined above.

Green (RoHS & no Sb/Br): TI defines "Green" to mean Pb-Free (RoHS compatible), and free of Bromine (Br) and Antimony (Sb) based flame retardants (Br or Sb do not exceed 0.1% by weight in homogeneous material)

(3) MSL, Peak Temp. - The Moisture Sensitivity Level rating according to the JEDEC industry standard classifications, and peak solder temperature.

(4) There may be additional marking, which relates to the logo, the lot trace code information, or the environmental category on the device.

(5) Multiple Device Markings will be inside parentheses. Only one Device Marking contained in parentheses and separated by a "~" will appear on a device. If a line is indented then it is a continuation of the previous line and the two combined represent the entire Device Marking for that device.

(6) Lead/Ball Finish - Orderable Devices may have multiple material finish options. Finish options are separated by a vertical ruled line. Lead/Ball Finish values may wrap to two lines if the finish value exceeds the maximum column width.

Important Information and Disclaimer: The information provided on this page represents TI's knowledge and belief as of the date that it is provided. TI bases its knowledge and belief on information provided by third parties, and makes no representation or warranty as to the accuracy of such information. Efforts are underway to better integrate information from third parties. TI has taken and continues to take reasonable steps to provide representative and accurate information but may not have conducted destructive testing or chemical analysis on incoming materials and chemicals. TI and TI suppliers consider certain information to be proprietary, and thus CAS numbers and other limited information may not be available for release.

In no event shall TI's liability arising out of such information exceed the total purchase price of the TI part(s) at issue in this document sold by TI to Customer on an annual basis.

DCP (R-PDSO-G**) 30 PIN SHOWN

PowerPAD™ PLASTIC SMALL-OUTLINE PACKAGE

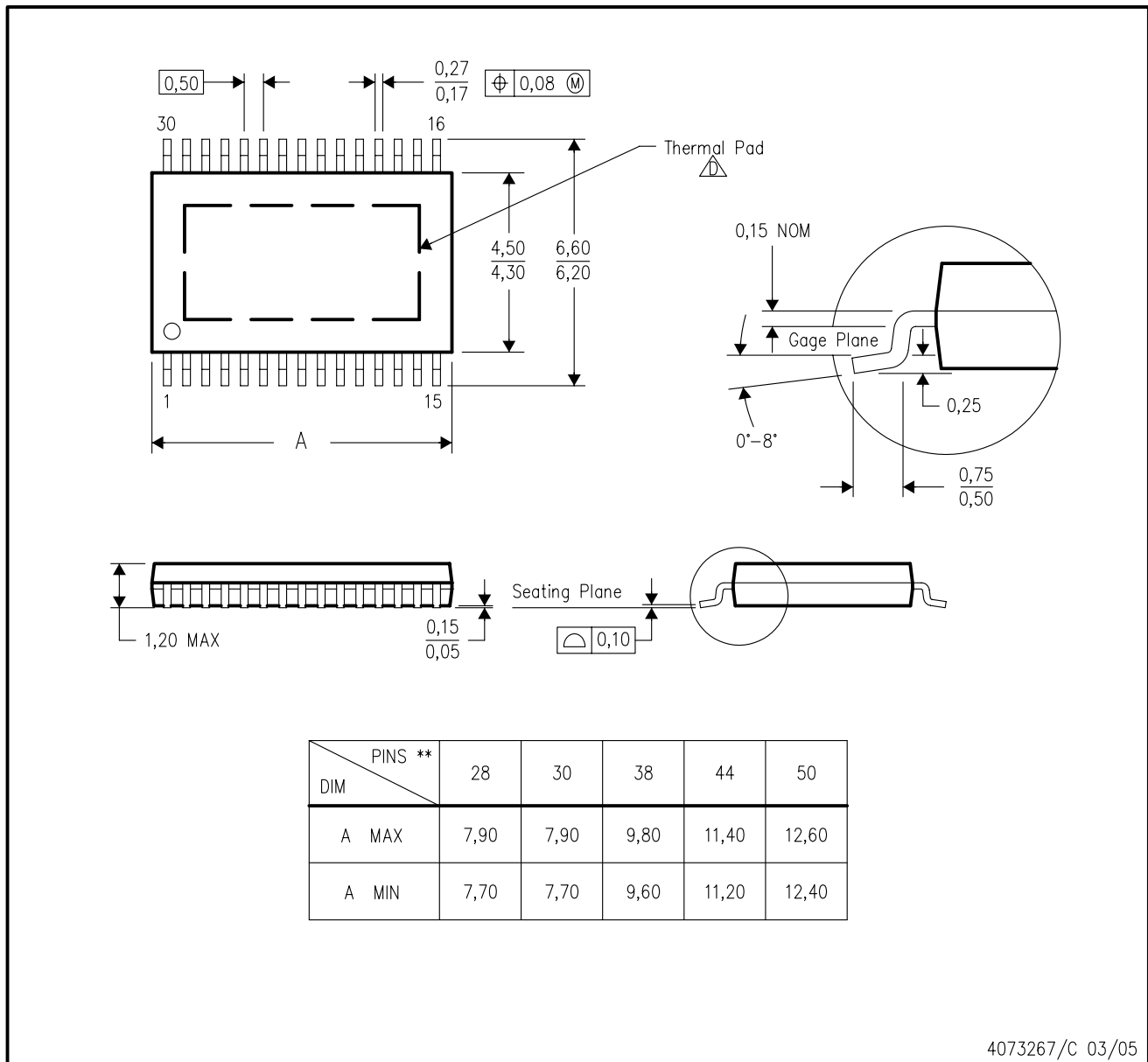

4073267/C 03/05

- NOTES:
- A. All linear dimensions are in millimeters.
 - B. This drawing is subject to change without notice.
 - C. Body dimensions do not include mold flash or protrusions, mold flash not to exceed 0.15mm.
 - D. This package is designed to be soldered to a thermal pad on the board. Refer to Technical Brief, PowerPAD Thermally Enhanced Package, Texas Instruments Literature No. SLMA002 for information regarding recommended board layout. This document is available at www.ti.com. See the product data sheet for details regarding the exposed thermal pad dimensions.
 - E. Falls within JEDEC MO-153

PowerPAD is a trademark of Texas Instruments.

IMPORTANT NOTICE

Texas Instruments Incorporated and its subsidiaries (TI) reserve the right to make corrections, enhancements, improvements and other changes to its semiconductor products and services per JESD46, latest issue, and to discontinue any product or service per JESD48, latest issue. Buyers should obtain the latest relevant information before placing orders and should verify that such information is current and complete. All semiconductor products (also referred to herein as "components") are sold subject to TI's terms and conditions of sale supplied at the time of order acknowledgment.

TI warrants performance of its components to the specifications applicable at the time of sale, in accordance with the warranty in TI's terms and conditions of sale of semiconductor products. Testing and other quality control techniques are used to the extent TI deems necessary to support this warranty. Except where mandated by applicable law, testing of all parameters of each component is not necessarily performed.

TI assumes no liability for applications assistance or the design of Buyers' products. Buyers are responsible for their products and applications using TI components. To minimize the risks associated with Buyers' products and applications, Buyers should provide adequate design and operating safeguards.

TI does not warrant or represent that any license, either express or implied, is granted under any patent right, copyright, mask work right, or other intellectual property right relating to any combination, machine, or process in which TI components or services are used. Information published by TI regarding third-party products or services does not constitute a license to use such products or services or a warranty or endorsement thereof. Use of such information may require a license from a third party under the patents or other intellectual property of the third party, or a license from TI under the patents or other intellectual property of TI.

Reproduction of significant portions of TI information in TI data books or data sheets is permissible only if reproduction is without alteration and is accompanied by all associated warranties, conditions, limitations, and notices. TI is not responsible or liable for such altered documentation. Information of third parties may be subject to additional restrictions.

Resale of TI components or services with statements different from or beyond the parameters stated by TI for that component or service voids all express and any implied warranties for the associated TI component or service and is an unfair and deceptive business practice. TI is not responsible or liable for any such statements.

Buyer acknowledges and agrees that it is solely responsible for compliance with all legal, regulatory and safety-related requirements concerning its products, and any use of TI components in its applications, notwithstanding any applications-related information or support that may be provided by TI. Buyer represents and agrees that it has all the necessary expertise to create and implement safeguards which anticipate dangerous consequences of failures, monitor failures and their consequences, lessen the likelihood of failures that might cause harm and take appropriate remedial actions. Buyer will fully indemnify TI and its representatives against any damages arising out of the use of any TI components in safety-critical applications.

In some cases, TI components may be promoted specifically to facilitate safety-related applications. With such components, TI's goal is to help enable customers to design and create their own end-product solutions that meet applicable functional safety standards and requirements. Nonetheless, such components are subject to these terms.

No TI components are authorized for use in FDA Class III (or similar life-critical medical equipment) unless authorized officers of the parties have executed a special agreement specifically governing such use.

Only those TI components which TI has specifically designated as military grade or "enhanced plastic" are designed and intended for use in military/aerospace applications or environments. Buyer acknowledges and agrees that any military or aerospace use of TI components which have **not** been so designated is solely at the Buyer's risk, and that Buyer is solely responsible for compliance with all legal and regulatory requirements in connection with such use.

TI has specifically designated certain components as meeting ISO/TS16949 requirements, mainly for automotive use. In any case of use of non-designated products, TI will not be responsible for any failure to meet ISO/TS16949.

Products

Audio	www.ti.com/audio
Amplifiers	amplifier.ti.com
Data Converters	dataconverter.ti.com
DLP® Products	www.dlp.com
DSP	dsp.ti.com
Clocks and Timers	www.ti.com/clocks
Interface	interface.ti.com
Logic	logic.ti.com
Power Mgmt	power.ti.com
Microcontrollers	microcontroller.ti.com
RFID	www.ti-rfid.com
OMAP Applications Processors	www.ti.com/omap
Wireless Connectivity	www.ti.com/wirelessconnectivity

Applications

Automotive and Transportation	www.ti.com/automotive
Communications and Telecom	www.ti.com/communications
Computers and Peripherals	www.ti.com/computers
Consumer Electronics	www.ti.com/consumer-apps
Energy and Lighting	www.ti.com/energy
Industrial	www.ti.com/industrial
Medical	www.ti.com/medical
Security	www.ti.com/security
Space, Avionics and Defense	www.ti.com/space-avionics-defense
Video and Imaging	www.ti.com/video

TI E2E Community

e2e.ti.com